

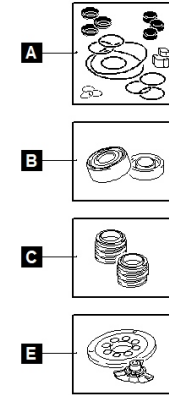

better together

1120.003 - GRBLUEP 200/2/G40H A1CM5 NGFEB51023N00NN

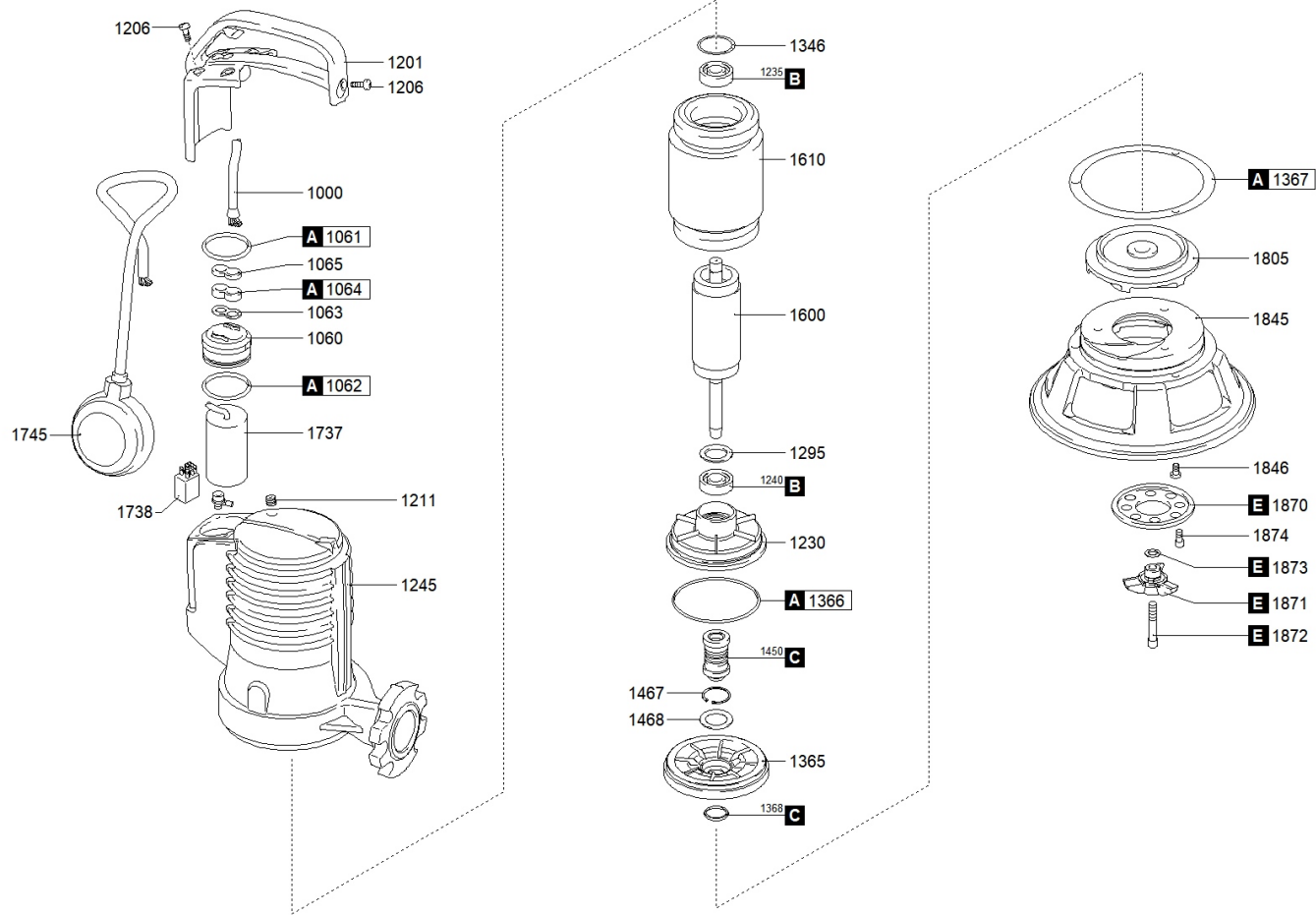



better together



1120.003 - GRBLUEP 200/2/G40H A1CM5 NGFEB51023N00NN

		Code		New Code		Description	Q.ty
A		601008001		9050.001		GASKETS KIT	1
C		602008051		9050.107		MECHANICAL SEALS KIT	1
E		603008001		9050.201		CUTTING SYSTEM KIT	1
1000		250102404010000000		2501NN00018		CAVO POTENZA	1
1060		239768026156		2397PL00001		HOLDER [CABLE GLAND]	1
1061		271770412835300000		2717GM00061		UPPER GASKET - HOLDER [CABLE GLAND]	1
1062		271770040952620000		2717GM00058		LOWER GASKET - HOLDER [CABLE GLAND]	1
1063		235467024280		2354PL00002		CABLE STOP	2
1064		235678024200		2356GM00031		RUBBER GASKET	1
1065		235467024241		2354PL00006		CABLE GLAND	1
1201		235361024325		2353PL00002		CABLE GLAND HANDLE	1
1206		270830510149200000		2708XX00087		SCREW [CABLE GLAND HANDLE >> COVER]	5
1211		270139510104000000		2701XX00003		CAP [TIGHTNESS TEST]	1
1230		230556323604		2305AL00002		LOWER BEARING HOLDER	1
1235		2729062030200000		2729NN00008		UPPER BEARING	1
1240		2729063050400000		2729NN00014		LOWER BEARING	1
1245		231016324324		2310GG00009		MOTOR CASE	1
1295		270220250352000000		2702AG00002		UPPER DISTANCE RING [LOWER BEARING]	1
1346		27542039100000		2754AG00003		WAVE SPRING	1
1365		2391120025023609		2391GG00003		MECHANICAL SEAL FLANGE	1
1366		271770107035000000		2717GM00003		GASKET [LOWER BEARING HOLDER >> MECHANICAL SEAL FLANGE]	1
1367		2750914423934		2750GG00004		GASKET [MECHANICAL SEAL FLANGE >> BASE]	5
1368		237970160220600000		2379GM00020		V-RING [MECHANICAL SEAL FLANGE]	1
1450		230005040180000000		2300NN00031		MECHANICAL SEAL	1
1467		270320450200000		2703AG00006		SEEGER [2nd MECHANICAL SEAL]	1
1468		270532021059027898		2705XX00003		DISTANCE RING [2nd MECHANICAL SEAL]	1
1600		230233612023760		2302NN00128		SHAFT WITH ROTOR	1
1610		231101201001000000		2311NN00039		WOUND STATOR	1
1737		2517028100000		2517NN00010		CAPACITOR	1
1745		254500405300000		2545NN00007		FLOAT SWITCH	1
1805		21411501000523670		2141GG00141		IMPELLER	1
1845		2145114423590		2145GG00007		BASE	1
1846		270830610203200000		2708XX00103		SCREW [BASE >> MOTOR CASE]	3
1870		211720624144		2117AG00001		CUTTING DISK	1
1871		211630824027		2116XX00006		CHOPPER KNIFE	1
1872		270830610453200000		2708XX00110		LOCKING CHOPPER KNIFE	1
1873		270620120180200000		2706AG00001		WASHER [CHOPPER KNIFE]	4
1874		270830610123200000		2708XX00097		SCREW [CUTTING DISK >> PUMP BODY]	3

